

Fortrose









FREESTANDING ELECTRIC STOVE

FOR20



Fortrose

Features

-  Unique Optimyst effect
-  2kW heat output
-  Choice of 2 heat settings
-  Thermostat
-  Remote control
-  Log effect fuel bed
-  Flame effect only
-  Opening doors
-  Freestanding - quick & easy to install

Fortrose



Remote Control



Fuel Bed



Logs

Fortrose

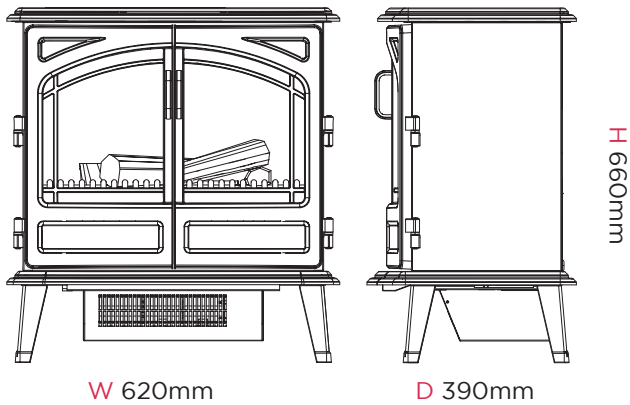

Dimensions & Weight

Height (mm)	Width (mm)	Depth (mm)	Weight (kg)
660	620	390	20.8

Product Features

Heat Output	2kW
Heat Settings	2 - 1kW / 2kW
Variable Thermostat	Y
Fan Heat / Radiant Heat	Yes / No
Location of Controls	Behind doors
On/Off Switch	Y
Remote Control	Y
Batteries Included	Y (2 x AAA)
Optimyst Effect	Y
Flame Type	Optimyst
Water Tank Size	1.1 Litre
Fuel Bed Supplied	Logs

Accessories

STP001 Stove Pipe	400000434
-------------------	-----------

Product Features

Product Category	Electric Fires
Product Type	Stove
Brand	Dimplex
Model/Range Name	Fortrose
Flame Effect	Optimyst
Model Reference	FOR20
Material Code	X-064585
Barcode	5011139064585
Approvals	CE/UKCA
Guarantee Period	2 years

Product Features

Lot 20 Compliant	Y
Freestanding	Y
Wall Mountable	N
Inset	N
Opening Doors	Y
Suite	N
Lamp Type	4 x 45W Halogen Bulb (Amber coated MR16)
Kettle (IEC) Lead	Y
Safety Cut Out	Y
Power Cord Length	1.8m
Core Materials	Steel/Plastic/Glass
Finish / Colour	Black